

Safe LED tube connection system

Eltako only uses the save LED tube connection system for its LED tubes.
LED tubes with the identification  are dimmable.

- Open pins never carry live voltage if the tubes are plugged into a socket on one side and then twisted.
Do not connect L and N to the same socket base.

- If Eltako LED tubes are used in luminaries instead of fluorescent lamps which were previously operated with a **conventional or low loss ballast**, only the starter needs to be replaced with the supplied starter bridge. Eltako LED tubes can be used in any position. See the wiring examples for **single circuit** and **double circuit**.
If dimmable Eltako LED tubes need to be dimmed, the electronic ballast must be bridged or removed by a qualified electrician.
- If Eltako LED tubes are used in luminaries instead of fluorescent lamps which were operated in **tandem circuits**, they must be rewired and then rewired or bridged like the conventional or low loss ballast. However, this can only be carried out by a qualified electrician using the connection example we specified. Eltako LED tubes can then be used in any position.
- If the starter is not removed from conventional or low loss ballast circuits, or if it was removed but not replaced by a starter bridge, the LED tube does not function but there is no short circuit.
- In addition to the energy consumption of LED tubes, a magnetic ballast which is not removed or not bridged has a high and unnecessary power loss and also causes high **voltage peaks** which shorten the service life of LED tubes. Removal or bridging may only be carried out by a qualified electrician. The power loss of electronic ballasts is much lower, therefore it is not as important to remove or bridge them over, unless the Eltako LED tubes need to be dimmed.
- **If a fluorescent tube is refitted to a lamp that was previously equipped with magnetic or electronic ballast and converted to LED tubes, the previous wiring with magnetic or electronic ballast must be restored to avoid a short circuit.**

- If Eltako LED tubes are fitted to lamps with an **electronic ballast** instead of fluorescent tubes, it must be rewired and the electronic ballast must be disconnected. However, this can only be carried out by a qualified electrician using the connection example we specified. Eltako LED tubes can then be placed in any position, even several tubes in parallel.
- **If a fluorescent lamp is fitted to a lamp previously fitted with an electronic ballast and converted to LED tubes, the previous wiring with the electronic ballast must be restored to avoid a short circuit.**

Further information

- **Operation in parallel with fluorescent tubes should be avoided since fluorescent tubes generate high voltage peaks.**
- The luminosity of LEDs is mainly dependent on the power feed. If the power feed is too high, it shortens service life. Instead we undershoot the reference values of the LED manufacturer by at least 5% and invest in better LEDs. In addition, we optimise the efficiency of power supply (Power factor 0.98!) and heat dissipation.
- The luminous flux of the LED tube also depends on the colour temperature K and the colour rendering index R_a besides power feed and the number of LEDs. The higher the colour temperature and the lower the R_a value, the brighter the LED tube. A R_a value of 80 may not be undershot, otherwise colours in the room are incorrectly reproduced. An R_a value of > 83 is even better!
- Eltako LED tubes are CE-conformant and comply with EN 62471, EN 62776 as well as IEC 62560.
- All dimmable Eltako LED tubes have been certified by KEMA-KEUR to EN and IEC regulations and therefore bear the test mark: 

Wiring Examples of Eltako LED Tubes

Wiring example of a single circuit luminaire with conventional or low loss ballast.

■ No wiring change is required (retrofit lamp), only the starter must be replaced by the starter bridge.

If dimmable Eltako LED tubes need to be dimmed as well as switched, the electronic ballast must be bridged or removed.

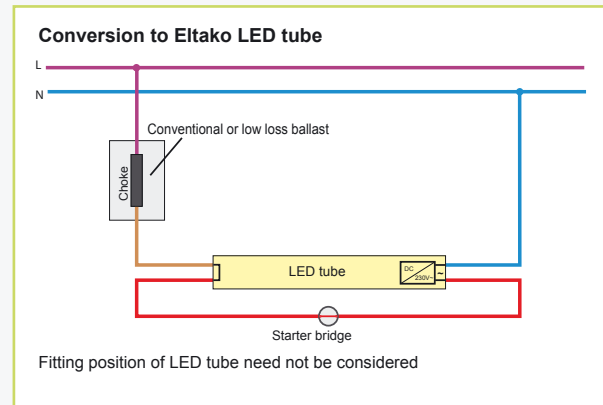
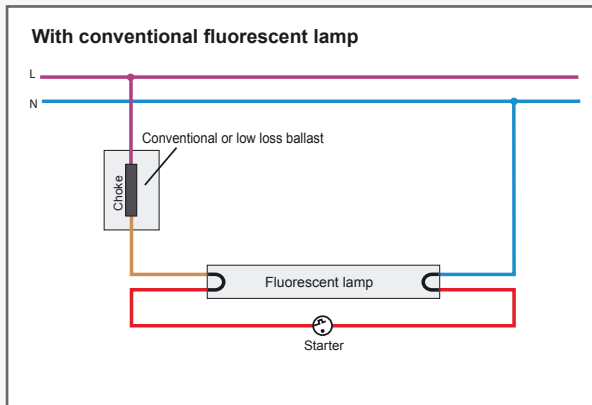

Wiring example of a double circuit luminaire with conventional or low loss ballast.

■ No wiring change is required (retrofit lamp), only the starter must be replaced by starter bridges.

If dimmable Eltako LED tubes need to be dimmed as well as switched, the electronic ballast and the compensator must be bridged or removed.

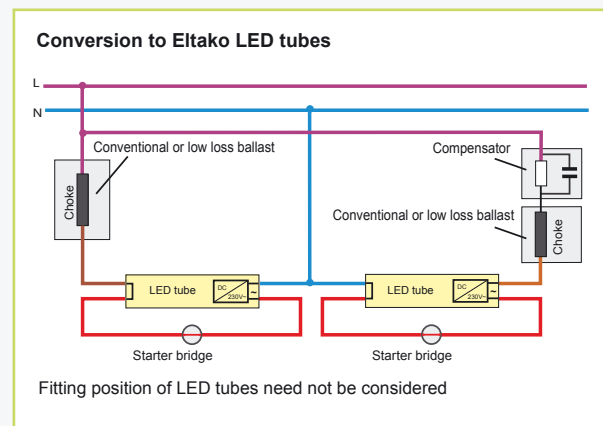
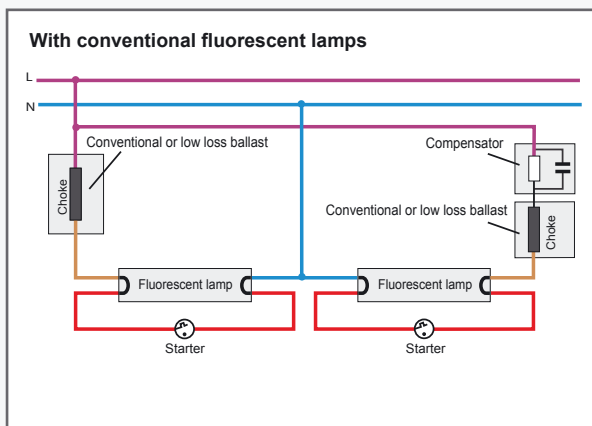

Installation instructions when used as retrofit lamp

- 1) Switch off power supply
- 2) Rotate conventional tubes through 90°
- 3) Remove conventional tubes carefully
- 4) Remove starter
- 5) Fit starter bridge (LRS)
- 6) Fit LED tubes
- 7) Rotate LED tubes through 90°. Note beam direction
- 8) Switch on power supply

Wiring example of a tandem circuit with conventional or low loss ballast.

- A wiring change is required (conversion lamp) and starters must be replaced by starter bridges.

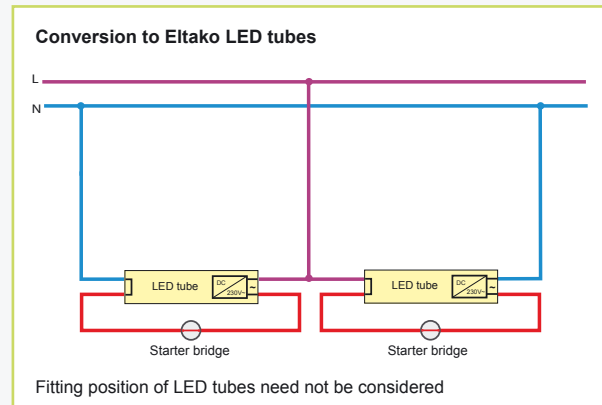
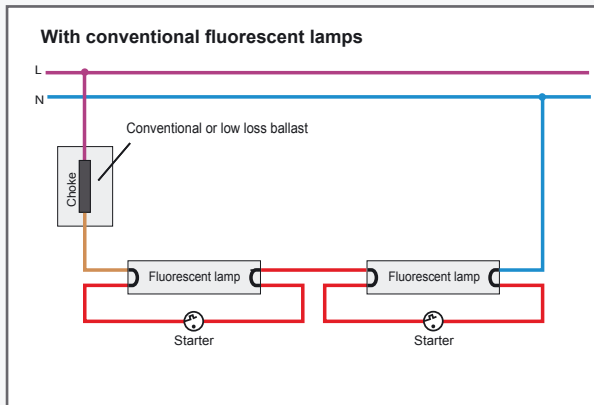



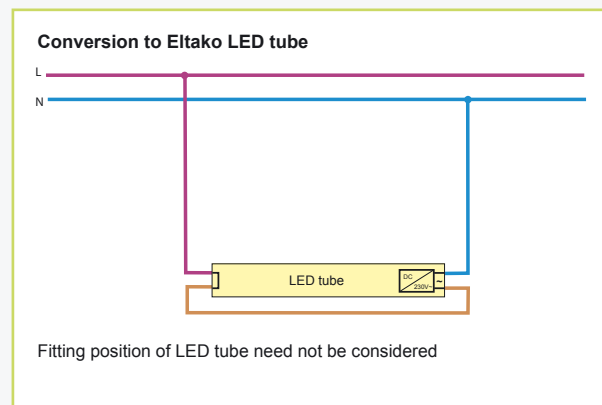
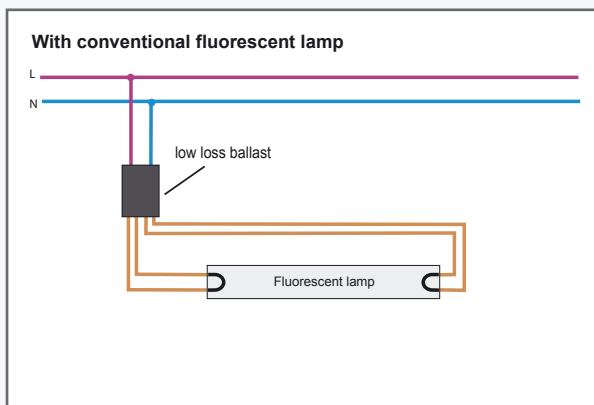

Wiring example of a luminaire with electronic ballast.

- A wiring change is necessary (conversion lamp), but no starter bridge is required.



Installation instructions when used as conversion lamp

- 1) Switch off power supply
- 2) Rotate conventional tubes through 90°
- 3) Remove conventional tubes carefully
- 4) Remove ballast and modify wiring
- 5) Remove starter
- 6) If necessary, fit starter bridge (LRS)
- 7) Fit LED tubes
- 8) Rotate LED tubes though 90°. Note beam direction
- 9) Switch on power supply

Type designation	LR06830M-12 W LR06840M-12 W LR06850M-12 W LR06865M-12 W NEW	LR12830M-20 W LR12840M-20 W LR12850M-20 W LR12865M-20 W NEW	LR15830M-20 W LR15840M-20 W LR15850M-20 W LR15865M-20 W NEW	LR15830M-28 W LR15840M-28 W LR15850M-28 W LR15865M-28 W NEW
Labelling of dimmable LED tubes				
Length	600mm	1200mm	1500mm	1500mm
Diameter	27 mm	27 mm	27 mm	27 mm
Socket	G13	G13	G13	G13
Weight	210g	365g	470g	470g
Service life in hours, max. approx.	50.000	50.000	50.000	50.000
Supply voltage ¹⁾	230V/50-60Hz	230V/50-60Hz	230V/50-60Hz	230V/50-60Hz
Current draw	0.05A	0.09A	0.09A	0.12A
Power consumption	12W	20W	20W	28W
Power factor	0.98	0.98	0.98	0.98
Ambient temperature max./ min.	+50°C/-30°C	+50°C/-30°C	+50°C/-30°C	+50°C/-30°C
Air humidity	10-90%	10-90%	10-90%	10-90%
Protection degree	IP 50 ²⁾	IP 50 ²⁾	IP 50 ²⁾	IP 50 ²⁾
Colour temp. K and luminous flux lm ± 5%				
Warm white 3000K	1260lm; 105lm/W	2100lm; 105lm/W	2100lm; 105lm/W	2940lm; 105lm/W
Cool white 4000K	1380lm; 115lm/W	2300lm; 115lm/W	2300lm; 115lm/W	3220lm; 115lm/W
Daylight 5000K	1440lm; 120lm/W	2400lm; 120lm/W	2400lm; 120lm/W	3360lm; 120lm/W
Cool Daylight 6500K	1500lm; 125lm/W	2500lm; 125lm/W	2500lm; 125lm/W	3500lm; 125lm/W
Colour rendering index (CRI) R _a	>83	>83	>83	>83
Reflected beam angle	140° ³⁾	140° ³⁾	140° ³⁾	140° ³⁾
Cover 360° (plastic)	frosted	frosted	frosted	frosted
Shatter resistance	yes	yes	yes	yes
Rear	strong aluminium profile inside the 360° cover	strong aluminium profile inside the 360° cover	strong aluminium profile inside the 360° cover	strong aluminium profile inside the 360° cover
Photobiological class as per DIN EN 62471 (RG0 = no risk)	RG0	RG0	RG0	RG0
Energy efficiency class according to EU Directive 874/2012	A++	A++	A++	A++
Weighted energy consumption according to EU Directive 874/2012	12 kWh/1000h	20 kWh/1000h	20 kWh/1000h	28 kWh/1000h

¹⁾ Also suitable for emergency lighting of 130 - 220 V DC.

²⁾ Applications in humid zones can also be implemented using a luminaire with suitable protection class.

³⁾ At the edge of the 140° beam angle, the brightness is still 50%. This value is reduced to 10% at 220°.

Operation in parallel with fluorescent tubes should be avoided since fluorescent tubes generate high voltage peaks.

LED tubes contain no mercury and after up to 50.000 operating hours, they are therefore not classified as hazardous waste but as recyclable electronic scrap. No UV or IR radiation

To dim these 230V LED tubes, we recommend universal dimmer switches FUD14, FUD61NPN, FMD70+FSD70, FUD70, EUD12NPN, EUD12D, EUD61NPN and MFZ12PMD.

All dimmable Eltako LED tubes have been certified by KEMA-KEUR to EN and IEC regulations and therefore bear the test mark: 